



# **JUSTICE - PLUS**

**PANEL OF RESEARCH ON THE PROLIFERATION AND ILLICIT TRAFFIC OF  
SMALL ARMS AND LIGHT WEAPONS IN THE FRONTIER AREAS BETWEEN  
SUDAN, UGANDA AND THE DEMOCRATIC REPUBLIC OF THE CONGO**

## **PROLIFERATION AND ILLICIT TRAFFIC OF SMALL ARMS AND LIGHT WEAPONS IN THE NORTH EAST OF THE DRC**

### **Summary Report**

by

**Flory KAYEMBE SHAMBA  
Désiré NKOY ELELA  
Missak KASONGO MUZEU**

**Kinshasa, January 2003**

## **JUSTICE-PLUS**

- **BUNIA**

*Siège social*  
39bis, Av. KASAVUBU, Q. Lumumba  
B.P 630-BUNIA  
Tél. : (+) 871762568941  
Fax : (+)871762568943  
E-mail : [justice\\_plus@yahoo.fr](mailto:justice_plus@yahoo.fr)

- **KINSHASA**

*Bureau de liaison*  
3, Av. KITONA, Q. Righini, C/Lemba  
B.P. 2063 Kinshasa 1  
tél. : (+)243 98171 100  
Fax : (+) 243 8801826  
E-mail : [justiceplus\\_blk@hotmail.com](mailto:justiceplus_blk@hotmail.com)

## TABLE OF CONTENTS

INITIALS.....	2
ACKNOWLEDGEMENTS.....	3
INTRODUCTION.....	4
<b>I. CONCEPTUAL AND METHODOLOGICAL FRAMEWORK .....</b>	<b>6</b>
➤ TERMES DE REFERENCE.....	6
➤ METHODOLOGY AND UNFOLDING OF THE RESEARCH.....	9
<b>II. OUTLINE OF THE SITUATION IN THE NORTH EAST OF THE DRC .....</b>	<b>10</b>
MAPPING OF CONFLITS IN ITURI AND UPPER UELE (Alliances and counter-alliances).....	12
<b>III. PRESENTATION OF DATE BY INVESTIGATION CENTRE.....</b>	<b>13</b>
<b>IV. SUMMARY OF RESEARCH FINDINGS .....</b>	<b>14</b>
4.1. GENERAL PERCEPTION OF THE CONFLITS .....	14
4.2. SMALL ARMS AND LIGHT WEAPONS : CIRCUITS OF ACQUISITION, COST, SOURCES OF SUPPLY, COMMERCIAL FLOW, IMPORTANCE .....	17
4.3. CONTROL OF THE CIRCULATION OF SMALL ARMS & LIGHT WEAPONS AND PROSPECTS FOR PEACE IN AFRICA'S GREAT LAKES REGION .....	20
4.4. VERIFICATION OF RESEARCH HYPOTHESES .....	23
<b>V. STRATEGIES OF FIGHT AND RECOMMENDATIONS .....</b>	<b>26</b>
5.1. STRATEGIES.....	26
5.1.1. At the local and national level .....	26
5.1.2. At the regional level .....	26
5.1.3. At the international level .....	27
5.2. RECOMMENDATIONS FOR ACTIONS IN THE SHORT, MEDIUM AND LONG TERM .....	27
5.2.1. To the government of the DRC .....	27
5.2.2. To the Congolese populations .....	27
5.2.3. To the three countries .....	28
5.2.4. To the international community .....	28
CONCLUSION.....	28
 <b>FIGURES :</b>	
Fig.1. Delimitation of the areas covered by the research .....	7
Fig. 2. North East of the DR Congo involved in the study.....	11
Fig. 3. Map of the North East of the DR Congo .....	13
Fig. 4. Routes of the illicit traffic and proliferation of small and light weapons towards the North East of the DR Congo .....	30

**INITIALS**

A.D.	: Aire de Discussion
A.L.	: Arme légère
ACIAR	: Appui à la Communication et à l'Auto promotion Rurale
AFDL	: Alliance des Forces Démocratiques pour la Libération
ALC	: Armée de Libération du Congo
APC	: Armée du Peuple Congolais
C.E.	: Centre d'Enquête
C.E.J.P.	: Commission Episcopale Justice et Paix
CIC	: Centre d'Initiative et de Créativité
CRC	: Centre de Résolution des Conflits
Fig.	: Figure
FOMI	: Forum des Mamans de l'Ituri
FPD	: Fondation pour la Paix Durable
Gouv.	: Gouvernement
HCR	: Haut Commissariat aux Réfugiés
ISEAV	: Institut Supérieur des Etudes Agronomiques et Vétérinaires
J.P.	: Justice-Plus
MLC	: Mouvement de Libération du Congo
MONUC	: Mission des Nations Unies au Congo
N.U.	: Nations Unies
OCHA	: Office of Coordination Humanitarian Affairs
ONG	: Organisation Non Gouvernementale
P.R.	: Panel de Recherche
PAL	: Prolifération des armes légères
R.D.C.	: République Démocratique du Congo
RCD	: Rassemblement Congolais pour la Démocratie
RCD/ML	: Rassemblement Congolais pour la Démocratie/ Mouvement de Libération
RCD/N	: Rassemblement Congolais pour la Démocratie/National
SPLA	: Sudan People's Liberation Army
UPC	: Union des patriotes congolais
UPDF	: Ugandan People Defence forces
Z.E.	: Zone d'enquête

## **ACKNOWLEDGEMENTS**

This preliminary research on the proliferation and traffic of small arms and light weapons in the North East of the DRC, frontier area shared with Sudan and Uganda profited from the knowledge, know-how and expertise of three researchers based in Kinshasa and of the partners based in that part of the DRC.

This report is thus the fruit of a collection endeavour by the Kinshasa Panel of Research and its investigators trained for the circumstance. The main initiator of this research is Pax Christi/Netherlands, who requested it through its Program Officer, Dr Joost van Puijenbrock. The financing obtained for this organisation made the realisation of this work possible.

Field investigations also received moral and material support, together with sound advice from Church and civilian authorities as well as from members of the Civil Society.

Our acknowledgements are also extended to the political and administrative authorities who made the task easier for the investigators, especially in investigation Centres and investigation areas selected by the Panel of Research, namely the investigation Centre of Aru, Isiro, Bunia and Mahagi in the respective investigation areas of Ariwara, Engbokolo, Isiro, Dungu, Doruma, Aba, Faradje, Bunia and Mahagi. Without the assistance of all the internal and external collaborators, this report would never have seen the light of the day. As such, this report is equally evidence of the collaboration, trust, commitment and availability of the surveyed population, especially the population of the above mentioned investigation centres and investigation areas.

Finally, the Panel of Research wishes to thank the support staff based in Kinshasa and in the investigation centres for the availability in the finalization and production of this report.

## INTRODUCTION

The Democratic Republic of the Congo is experiencing a period of acute crisis a simultaneously political, economic and social, but mainly military crisis. The military aspect of the crisis has brought about the flow of S.A. & light weapons in the areas or territories occupied by non-official armed groups, supported by neighbouring and far-off countries. It is the military intervention, with all its consequences, which challenges and arouses a great interest among all the organisations which plead in favour of peace and peaceful cohabitation of peoples.

It is thus within this framework of the problems of the traffic and proliferation of deadly weapons that Pax Christi/Netherlands, whose vocation is the building of peace, is concerned and thinks that a thorough research may help in order to devise the mechanisms and strategies likely to at least reduce or minimise, if they cannot put an end to, the infernal cycle of violence in the Great lakes Region.

The Panel of Research of the DRC was asked by Pax Christi/Netherlands to organise and conduct this research on the illicit traffic and proliferation of light weapons in the frontier areas between Sudan, Uganda, and the Democratic Republic of the Congo.

Aware of the stakes of this question, the Panel designed a methodological framework of analysis which was flexible and adaptable to local contingencies so as to collect a maximum of data on this problem.

The collected data were communicated in a rough way so as to allow a meticulous examination, an analysis and a synthesis which are objective and appropriate as far as the Panel's coordination is concerned.

The fight against the uncontrolled proliferation and illicit traffic of light weapons is a Way of the Cross, of which the end depends on our capacity to mobilise both local and international communities and on the will of the said communities to commit themselves resolutely. A lasting peace is possible only if a common plea action involving individuals, communities and nations is taken.

The threat to peace by the presence of light weapons : need for a participatory reflection.

Because of the cycle of violence experienced in the Region, the frontier areas between Uganda, Sudan and the Democratic Republic of the Congo have become the theatre of

the proliferation of light weapons. The mode of their acquisition, their use and their presence inside the communities threaten peace and collective security.

It is within this framework that Pax Christi/Netherlands, worried by this question, has expended itself to prepare an international meeting aiming to study the question of the proliferation of S.A. & light weapons in this region and their incidence on the outbreak of conflicts between communities and countries. It will also be a question of outlining some answers and tracks to the building of the peace which the population needs for an integral, integrated, and sustainable development.

Our summary report comprises five points representing the five chapters of the report :

- Conceptual and methodological framework of research
- Outline of the situation in the North East of the DRC
- Presentation data by investigation centre
- Summary of research findings
- Strategies and recommendations.

## **I. CONCEPTUAL AND METHODOLOGICAL FRAMEWORK**

The problem of the proliferation and illicit traffic of S.A. & light weapons reveals an obvious interest in the search for a lasting peace. The Panel of Research entrusted with this study put forward the conceptual and methodological framework of the research in order to delimit the content, the methodological progression and the tools for the collection of data.

In preparation for the International Conference on the proliferation and illicit traffic of light weapons, Pax Christi/Netherlands initiated a project of research in the frontier areas between the DRC, Uganda and Sudan. In the Democratic Republic of the Congo, the research was undertaken by three Kinshasa based researchers and several investigators based in the North East of the DRC, members of different denominational and human rights organisations in Ituri and Upper Uélé. The Kinshasa based researchers are members of the following organisations :

1. « Groupe Amos » : Flouy Kayembe Shamba ;
2. « CEJP » : Désiré Nkoy
3. « J.P. » : Missak Kasongo

### **TERMS OF REFERENCE**

The object of the research is the proliferation of S.A. & light weapons in the frontier areas between Sudan, Uganda and the DR Congo.

This research was carried out in preparation for the International Conference on the proliferation and illicit traffic of light weapons, to be held in Arua (Uganda) by three complimentary research teams from the Congo, Uganda, and Sudan.

The conference, mobilizing representatives of local government, security forces, churches and non government organisations from these three countries, purposes to develop strategies, for a coordinated action by these three countries and various official on non official actors, against the increase, use and cross-bonder illicit traffic of S.A. & light weapons.

**Fig. 1. Delimitation of the areas covered by the research**

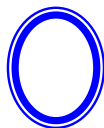

**Areas covered by the research**

➤ ***Expected results :***

The research tried to answer the following questions :

- a. Who holds and uses weapons in many of the selected frontiers communities ?
- b. To what end are they using these weapons : personal protection, the protection of the community, criminal activities, participation in rebel or war lards' armies, etc ?
- c. Arms Markets : How are the weapons obtained ? What is the price ? What benefits does one gain from the traffic of weapons ? Who are the dealers ? Can one obtain an estimate of the size of this trade ?
- d. What are the measures envisaged in order to control the trading in and use of weapons, and what is their efficacy ?
- e. Based on the research findings, can one identify strategies in order to slow down the proliferation of light weapons and improve the security of communities ?

➤ ***Research hypotheses***

1. The presence of foreign armies may foster the inflow of weapons in the area ;
2. Economic and financial objectives encourage the proliferation of light weapons ;
3. The existence of ethnic militias and armed gangs favours the proliferation of light weapons ;
4. The inflow of refugees owing to the war might have brought about the proliferation of weapons ;
5. The inefficient administration of the area may encourage the search of personal safety to the detriment of the search of collective, safety individuals thus getting weapons for their own safety ;
6. The evacuation of occupying troops may bring about the proliferation of light weapons as these are left with the local population ;
7. The use of weapons for poaching purposes causes the circulation of S.A. & light weapons ;
8. The illicit trade of weapons, simply being lucrative, increases the circulation of light weapons;
9. The plundering of natural resources causes the traffic and proliferation of S.A. & light weapons.

## **METHODOLOGY AND UNFOLDING OF THE RESEARCH**

In order to carry out the research for the collection of data, the DRC's Panel of Research prepared a questionnaire which was administered to individuals in the investigation centres.

The administration of the questionnaire was preceded by the training of 11 researchers set out as follows

- Aru centre (05 – 06 November, 2002) : three investigating researchers were trained ;
- Isiro centre (08 – 09 November, 2002) : five investigating researchers were trained ;
- Bunia centre (11 – 13 November, 2002) : two investigating researchers were trained ;
- Mahagi centre (15 – 18 November, 2002) : one investigating researchers were trained .

The collection of data unrolled in an active and participatory way in the different investigation areas. It was made through interviews with and administration of the questionnaire to the target population. In the investigation areas, the investigating researchers worked in difficult conditions taking into account the difficulties of transport and the generalised insecurity in the districts of Ituri and Upper Uélé which constitute the theatre of violent confrontations between armed factions, rebel groups and foreign armies.

Certain data could not be collected because of the high risk factors noticed by the researchers on the ground. Certain investigation centres or areas, such as Bunia, Mahagi and Faradje, could provide only partial data taking into account the local political situation. The mistrust and hostility of some respondents made data collection arduous. Owing to harassment, some data could not be conveyed to the Kinshasa centre of analysis.

The various research data were distributed among the researchers. The researchers then met for a pooling of the outcomes of their work of analysis, which made it possible to make a summary of the research results. This analysis occurred from the 2<sup>nd</sup> to the 25<sup>th</sup> of January 2003.

## **II. OUTLINE OF THE SITUATION IN THE NORTH EAST OF THE DRC**

The North East Area of the Democratic Republic of the Congo, like certain other parts of the country, is undergoing peculiar, recurring violence caused by a difficult cohabitation between ethnic groups, and the presence of internal and external armed groups. Certain groups, at the conquest of power, formed rebel movements and transformed the North East of the DRC into a battlefield.

Before dealing with the study of the proliferation and illicit traffic of S.A. & light weapons, we found it useful to make an outline of the situation of the North East of the DRC so as to understand the geographic, historical, socio-economic and culture factors of the surveyed area.

Indeed, the region's demographic dynamics showed that there are cross-border populations who belong to the DRC, Uganda and Sudan. The play of alliances can be elucidated on the basis of ethnic, cultural and historical affinities quite real between the populations of the three countries. As the borders inherited from colonization are only artificial boundaries naturalness eliminates these borders and facilitates a recognized permeability of the geographical and politico-administrative boundaries of these countries.

The extreme wealth of the subsoil of Upper Uélé and Ituri justifies the increased interest of war lords and of the neighbouring countries in this region. If it steals the limelight from the other parts of the country, it is particularly because of the economic interests that it represents. This situation is accentuated by the organisation, before the current war and conflicts, of an intense commercial network between the North East of the DRC, Sudan and Uganda.

The understanding of the spatial and historical context of Ituri and Upper Uélé helps to better delineate and the problem of S.A. light weapons which is the object of our research.

**Fig. 2. North East of the DR Congo involved in the study.**

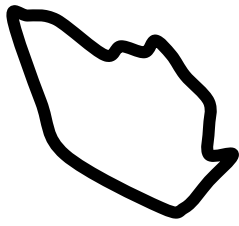
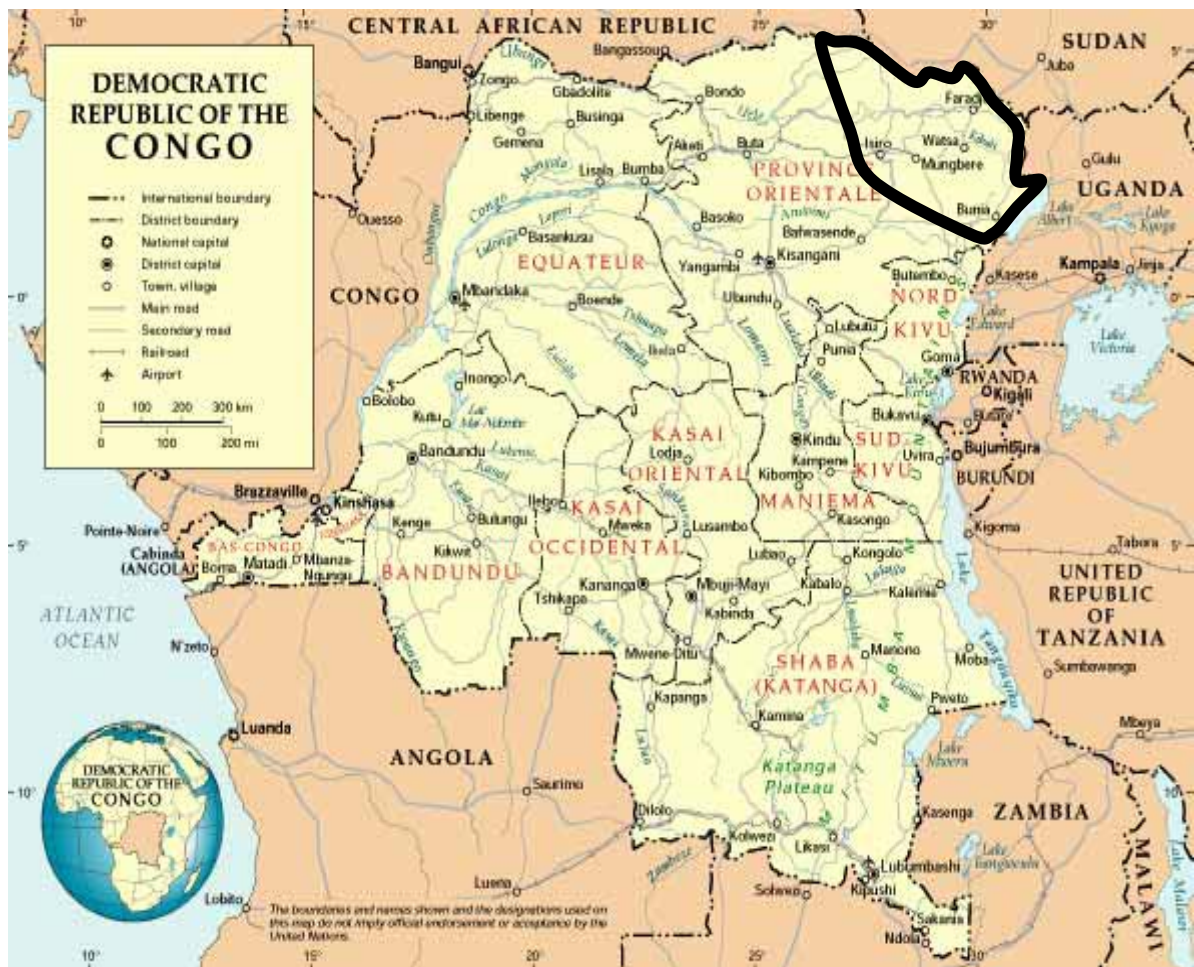

**Congolese investigated regions**

### MAPPING OF CONFLITS IN ITURI AND UPPER UELE (Alliances and counter-alliances)

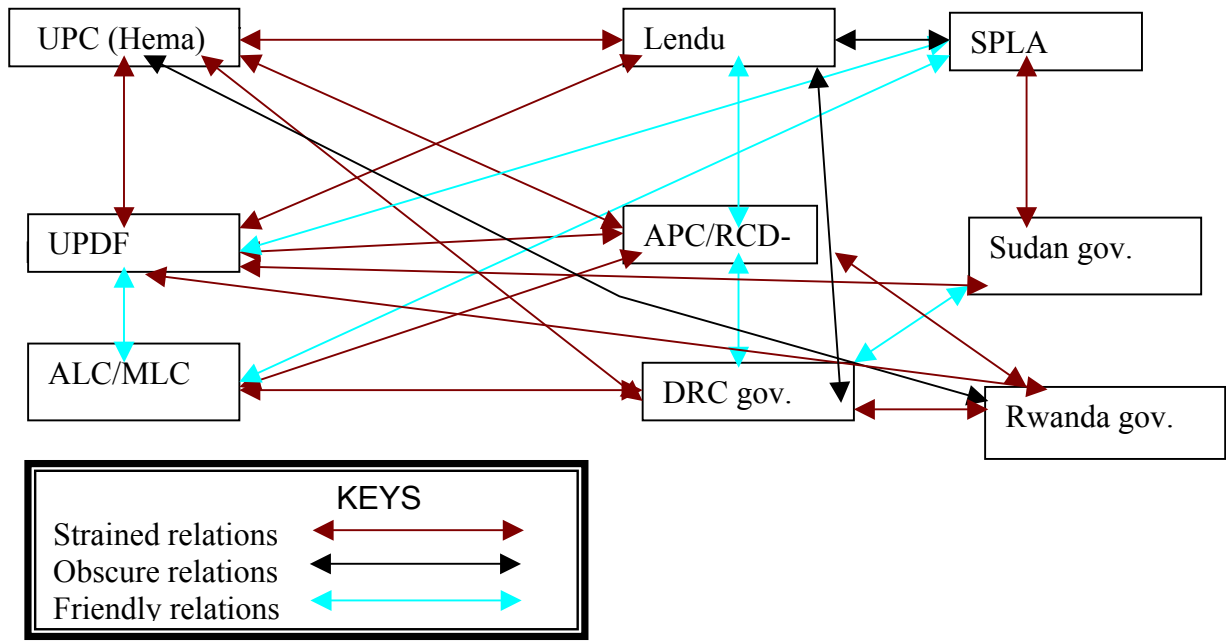

### III. PRESENTATION OF DATE BY INVESTIGATION CENTRE

After collection, the date from each investigation centre were analysed. In fact, each research had to deal with a certain number of questions that were put to the target population of these centres, and to bring out similarities and differences in terms of percentage of each question that was asked.

The results of these analyses were presented in a rough way, that is, as the respondents had formulated them. There is much similarity in their reactions, which makes us say that these populations were experiencing identical situations as for the plundering of resources or private or public property, as for the methods of slaughter used by men under arms, etc.

The trauma is widespread in these regions. The populations ardently wish peace, the cessation of internal and external hostilities, the restoration of the State and of its authority on all the expanse of the Democratic Republic of the Congo, the efficacious control of the weapons used by the authorized services, that is, the soldiers, the police, the intelligence services, the hunters,... licensed to carry weapons. This, in order to make not only the holders of power but also the Congolese population feel secure because, as they think, true security is collective, not selective.

**Fig. 3. Map of the North East of the DR Congo**

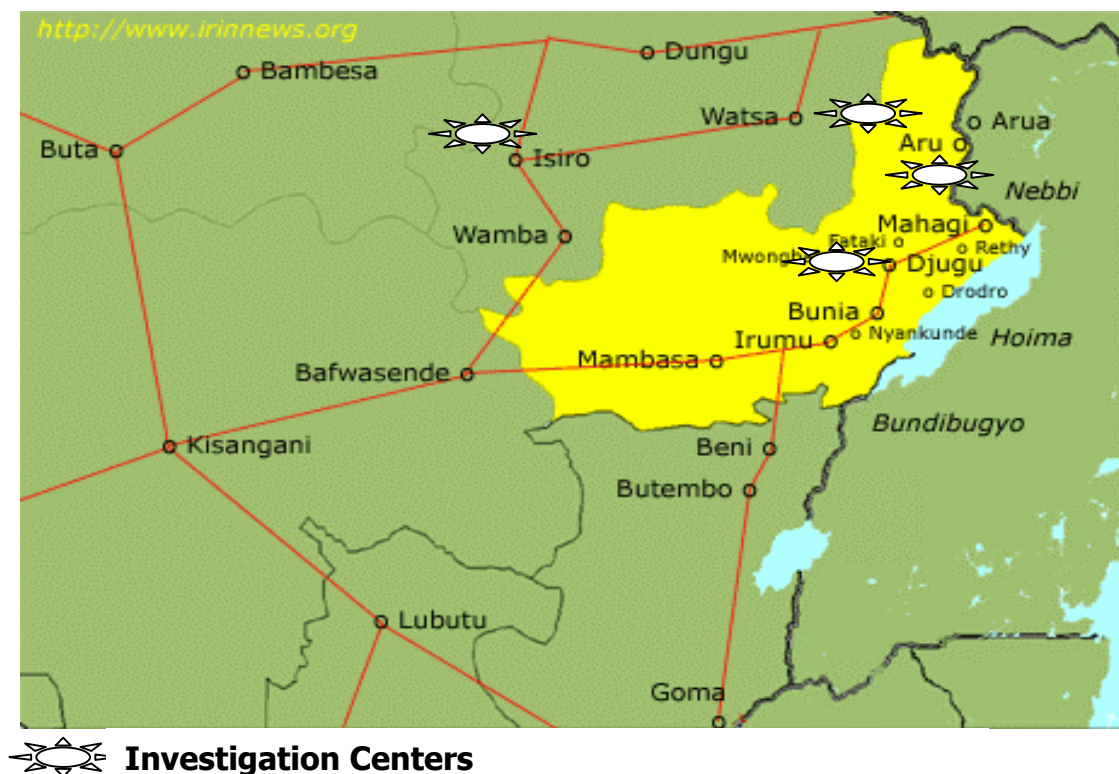

## IV. SUMMARY OF RESEARCH FINDINGS

This is a summary of similar and particular points stated in the reports from the various investigation centres.

### 4.1. GENERAL PERCEPTION OF THE CONFLICTS

#### ***Description of known conflicts in the different regions that were surveyed and the possible peace initiatives that are started.***

a) In all the areas surveyed and after the analysis, of the date, it comes out that the conflicts broke out between the years 1960 and 2002. Thus, for 42 years, these populations have not experienced a stable situation and a true peace. Since the country's independence, while passing by the rebellions of that time by Mobutu's seizure of power, by AFDL's rebellion and the current rebellion, these populations have experienced rebellions, ethnic and tribal wars intensified with the passing time by the flow of refugees sometimes Sudanese, sometimes Ugandan, and finally Rwandan.

b) Causes of conflicts

- *Remote causes*

Many respondents refer back to the war which opposed Idi Amin to Obote. Some others mention the overthrow of the dictatorial regime of the late Mobutu who had not prepared the succession in order to avoid the work which is being experienced today. Other respondents finally evoke the massive inflow of refugees from neighbouring countries, which inflow brought about a generalised insecurity, thus creating a political space for all the power-and-wealth thirsty opportunists.

The covetousness of foreign powers for the DRC's riches and their struggle for geostrategic and political leadership should not be forgotten. The political instability of the countries of the Great Lakes region and the absence of good governance do not protect these populations against internal and external conflicts.

- *Immediate causes*

Among the immediate causes, one quotes the unrestrained quest for power by Congolese politicians, manipulated by external forces for interests known only to themselves, and also the permeability of the borders which brings about the incursions of regular troops, with their allies, in DRC.

c) Main actors of the conflict

The data that were collected reveal that the main actors of these conflicts are notably the Congolese politicians who prove to be unable to privilege the national interest.

Secondly, the political, economic and financial powers of the Western and American world who keep on fighting for the control of their resources and pouring weapons and ammunition of the post cold war on the market of the Great Lakes Regions, thus creating Congolese as well as foreign rebel movements.

d) Internal and external factors having accentuated and fed these conflicts.

- *Internal factors*

Among the internal factors which fed this conflict, one quotes :

- the generalised insecurity into which the population and their property are plunged ;
- the unrestrained rush for wealth ;
- the uncontrolled sale of light weapons to civilian populations ;
- the political immaturity of Congolese leaders and the lack of a political idea which characterizes them ;
- an undisciplined army with no republican ideal

- *External factors*

- the policy selectivity of section or partiality practised by the international community, notably in its intervention in the resolution of conflicts in the Great Lakes region ;
- the political instability due to the choice of leaders by foreigners ;
- the covetousness of foreign political, economical and financial powers for the country's wealth ;
- the incursion of armed gangs from neighbouring countries (Uganda and Rwanda) which indulged in acts of vandalism.

e) Internal and external factors having attenuated these conflicts

- *Internal factors*

- Popular resistance through the organisation of militias for the community's self-defence ;
- Peace initiatives such as the agreements signed by the belligerents, with the claimed withdrawal of foreign troops as a corollary ;
- The refusal of the population to be subservient to political ideologies ;
- The unchecked plundering of ores and the payment of wages to the State's employees, the resumption of school activities in certain areas.

- *External factors*

- the mediation of Belgium, of South Africa and of the USA ;
- the embargo on Congolese diamond ;
- the presence of the United Nations observers ;

- the intervention of the HCR ;
- openness towards other people and the fact of agreeing to made concessions ;

f) The experience of these conflicts by individuals and communities :

On the whole, these conflicts have been traumatizing tragic and dramatic for the people, individuals and communities, a threat to their existence, and have caused division, the reflex of violence and a psychosis of permanent fear.

g) The consequences are numerous :

Firstly, there is a big surge of displacement of local populations wandering in all directions, seeking a shelter. These conflicts also resulted in the proliferation and massive sale of light weapons, voluntary or forced enrolment of minor children in the army (child-soldiers), the propagation of HIV/AIDS, failure to respect human rights, the interruption of development activities, the total collapse of the State, the impoverishment of the population, etc.

h) Peace initiatives

Opinions vary from area to area in respect to this situation. About 55 % affirm that there have been some peace initiatives here and there, notably

- the people's self-defense ;
- the pastoral ;
- the delimitation and demarcation of lands ;
- the negotiations between the Alur and the Lendu people ;
- MONUC's intervention ;
- The civil society through certain non government organisations took the initiative to reconcile the conflicting parties, etc.

As for the actors directly or indirectly concerned in these initiatives, the respondents quotes :

- the youth of the area ;
- religions authorities ;
- the allies of the rebels ;
- the officials of tribal friendly societies, etc.

In general, these initiatives did not lead to the expected results of a true and lasting peace in these areas.

## i) Actions to be undertaken for a lasting peace

As for actions that could be undertaken for a lasting peace, the respondents suggest :

- the pacification of the country and reconciliation ;
- the sensitising and awakening of all the citizens to collective security ;
- the demilitarisation of militias ;
- the demobilisation of all child soldiers ;
- the installation of monitoring services at the frontiers ;
- the application of the resolutions of the United Nations on the conflict in DRC ;
- the creation of a criminal court for the DRC ;
- the reorganisation of the national army and the control of weapons.

Concerning the actors to be implied in these actions, the respondents quote in particular :

- the civil society ;
- the officials of the parties in conflict ;
- the neighbouring countries Heads of State ;
- churches ;
- traditional chiefs ;
- the Security Council as a decision-making organ of the United Nations
- people who care about the common good.

#### **4.2. SMALL ARMS AND LIGHT WEAPONS : CIRCUITS OF ACQUISITION, COST, SOURCES OF SUPPLY, COMMERCIAL FLOW, IMPORTANCE**

- a) On the whole, the respondents confirm having heard a small arm, which represents more or less than 86 %. These people define a small arm as a fire arm, which is portable, dismountable, transportable, and can be handled even by a child aged less than 15 years. Its use does not require any specialised training.

Among the known types of small arms, the respondents quote inter alia : AK 47, M16, FAL, CALIBRE 12 and 16, FALLO, GRENADE, g3, UZI, KALACHNIKOV, REVOLVER, PISTOLET, GRENADE, FARE, MAUSER 32 and 52, SEMI-LIGHT, 22 LONG, MAG, UN 30, PUPU, and some non firearms used in these conflicts such as machetes, knives, spears, arrows, etc.

These weapons are used either for self-defense (personal or collective security) or for hunting. Other reasons are the following : poaching, intimidation of populations by rebels, crime, plundering of ores, conquest of power and territories, armed robbery and rape, inter-ethnic conflicts, etc.

The possession and use of these weapons in the area are attributed to Congolese and foreign soldiers, to hunters in the park, to refugees, to rebels and their allies, to big tradesmen, to deserted soldiers, etc.

The data that were collected reveal that the weapons come from various sources.

One quotes :

- Uganda at 90 % according to the respondents ;
- Sudan
- Rwanda
- The West
- Ex Soviet Union countries ;
- Stocks abandoned by deserted soldiers
- Locally manufactured non fire arms.

b) Salesmen and cost :

- Uganda
- The Congolese armed forces
- The Congolese rebels ;
- The officers of the armies that are present in the areas
- Businessmen
- Western countries and the USA
- Local manufacturers
- Unidentified people.

The price is a true secrecy of this market. According to the respondents, it is impossible to estimate the actual cost of the sale of these weapons. Nevertheless, some respondents indicate that in certain regions they would cost between US \$50 and 150 ; but the majority affirms that one can acquire a weapon by barter or the exchange of mining products or other (cigarettes, for example).

c) Entry and circuit of these weapons in the various areas

90 % of the respondents indicate that these weapons enter via the frontiers at night, clandestinely and fraudulently either by bicycle, on foot or by vehicle and dissimulated in wares allegedly presented as ration for the soldiers. Certain weapons come in by air bags of coffee. One respondents located at frontier market at Nabiapai, at Kakesa near Faradje. It is certain that there are other unidentified points of sale all along the frontiers as everything is done clandestinely and sometimes with the complicity of customs officers.

Uganda and Sudan are quoted among many other large suppliers. The far-off suppliers that are quoted are the USA, the ex USSR, South Africa. The Ugandan government is widely quoted for the fact of having supported rebel movements for a long time.

- The profiteers of the illicit trade of small arms and light weapons

This trade, as stated by the respondents, certainly benefits those who are practising it in order to enrich themselves and to perpetuate conflicts in this part of Africa. The proportion of the benefit is difficult to estimate in terms of percentage ; nonetheless it is certain that they can buy everything that they need, for example food,... and capital equipment without feeling the cost of living.

- The impact of rebel movements in the proliferation and the illicit sale of light weapons :

This impact is obvious. One can retain inter alia :

- the insecurity in the area ;
- the destruction of the fauna and the flora ;
- failure to respect human rights ;
- illicit carrying of light weapons by anybody ;
- continuation of the rebellion ;
- generalized misery, etc.

d) The presence of foreign armies

94 % of the respondents think that the presence of foreign armies contributed to the proliferation and the illicit sale of these machines. That manifests itself in the flare-up of acts of violence and the multiplicity of tribal and ethnic militias in these areas, as well as in the number of deaths that one keeps on deploring today.

e) Opinions vary concerning the commercial flow between the North East of Africa's Great Lakes region and Dubai. Some say that, doubtless, this is at the base of the proliferation and illicit sale ; some others think that this plague is due to this trade in as far as the supply in stable convenience goods comes from Dubai, small arms and light weapons may also come in to DRC via the same way, dissimulated like any other ware.

f) 75 % of the respondents opine that the presence of these deadly weapons enormously contributes to the constitution and the multiplicity of armed gangs and , also to the emergence of rebel movements, this can be confirmed by the insecurity

and the installation of people's self defence organisations and ethnic militias in the area.

- In general, the respondents think that it is impossible to estimate the number of light weapons held by individuals, communities, and armed gangs in all these areas. Nonetheless it is believed that there are more or less 2 to 13 thousand light weapons in circulation particularly since a Lendu chief would have declared that he had 10.000 well armed men in the bush. May one thus believe that he has at least 10.000 weapons ? And by extrapolation, we can also say that each chief of a militia, estimated at 10.000 as in the case of the Lendu chief, would have the same number of weapons. It should also be noted that the respondents declare that each adult possesses at least one arm for his protection. One thereby notices an increasing number of light weapons, difficult to estimate.
- The relation between the proliferation of light weapons and the plundering of natural resources in the conflict areas and the criminalisation of the economy is quite obvious. The proliferation of small arms and light weapons undoubtedly fosters the plundering of natural resources and hinders the economic development of the area.
- Solidarity and coalitions around the proliferation of light weapons :  
70 % of the respondents speak of various acts of solidarity and coalitions which are developed on the proliferation of light weapons, in particular the initiatives of young people for peace and self-defence, the government and its self reliance, the Hema people and Ugandan officers, the « DRC » and Rwanda, coalitions between ethnic groups, etc.

#### **4.3. CONTROL OF THE CIRCULATION OF SMALL ARMS & LIGHT WEAPONS AND PROSPECTS FOR PEACE IN AFRICA'S GREAT LAKES REGION**

- a) 50 % of the respondents claim to be informed of the internal and external legal provisions which regulate the trade of small arms and light weapons. Among the provisions that one seems to know one can quote the military penal code and the military code of conduct which in fact forbid the holding of a firearm by anybody without the authorization of the competent authority. One indicates the constitution, which determines useful orientations on this matter. Some other respondents are unaware of these provisions.

Failure to observe these provisions is due to impunity, institutional instability, illiteracy, military indiscipline, crisis of authority (the non-existence of the State and

of the unity of command), to the rebellion which is synonymous with insubordination and finally to the guilty slowness of the United Nations in the application of the relevant resolutions.

In order to enforce these provisions, it is necessary at first to restore the authority of the State, to take the needed exemplary sanctions, to institute peace and security and to ensure a rigorous control of the carrying and use of firearms.

According to the majority of respondents, traditional practices once existed, but today the traditional authority is ridiculed and has no seizure control of the possession and use of small arms and light weapons in particular as these illegally come from everywhere.

These traditional practices are not complied with because the traditional authority is ridiculed and there is no collaboration between the civilian, military, and traditional authorities on this matter ; hence the impunity and quest for egotistic interests.

In order to enforce these provisions, it is necessary to :

- restore the traditional authority ;
- work in collaboration with it ;
- sensitize the population ;
- apply the existing laws ; etc.

Possible measures of control

- to reinforce intelligence services at the frontiers ;
- to regulate the issuing of permits for carrying firearms ;
- to organise a conference on light weapons in the Great Lakes region ;
- repurchase by the State of the weapons held by the civilians,
- institution of democratic regimes in the Great Lakes countries ;
- to disarm illegal holders of small arms and light weapons.

b) To slow down the proliferation of small arms and light weapons, it is necessary to :

- first of all put an end to the war ;
- establish a collaboration on the matter with neighbouring countries ;
- collect stray weapons ;
- involve the UNO in this process ;
- improve the relevant legislations in the three neighbouring countries ;
- organize joint patrols along the borders ;

- c) Measures to take in order to collect the weapons currently in circulation from individuals, communities and armed gangs :

On such measures, the respondents suggest :

- the pacification and the unification of the country and of the public authority ;
  - the demobilization of ex combatants ;
  - the confinement of soldiers in the barracks ;
  - the demilitarization of civilian districts ;
  - the collection of weapons in collaboration with the traditional authority.
- d) The majority of respondents say yes and no to the question of knowing if it is possible to disarm rebel movements in this moment of the consolidation of the achievements of the peace process ; yes if the international community, through the MONUC, becomes involved in the rigorous control of the supply of weapons and ammunition to the insurgent chiefs ; no as the peace process has already started but the army is not unified yet and there is not an administration likely to be mobilized for this purpose. They also add that it is first of all necessary to cure the wounds caused by the war, hatred, and xenophobia.

In order to improve the security of individuals, of communities, and of their possessions in the current context of the area for thus discouraging the proliferation and possession of light weapons, the respondents suggest that one should :

- Share power equitably ;
  - Reinforce civil and military justice ;
  - Sensitize the population on the question of collective security ;
  - Deploy well trained, mixed and / or neutral troops,
  - Sanction the transgressions.
- e) In respect of the infernal cycle of conflicts in the Great Lakes region, the majority of respondents thinks that it is possible to envisage a conference on peace in the Great lakes through a meeting of the countries involved, in a place to be agreed upon.

According to the respondents, the following themes would have the priority at such a meeting :

- Peaceful cohabitation and reconciliation ;
- Regional political and economic integration ;
- Promotion of human rights in the three countries ;
- The construction of a lasting peace for a sustainable development ;
- Democratization and good governance in the official institutions of these countries ;
- Questions related to regional security.

The respondents suggest the following as essential points which can be the object of the Agreement on Peace and Collective Security in the Great Lakes Region:

- the securitizing of the common borders;
- the common control of the borders;
- the consolidation of a regional organization of political, economic and cultural integration;
- commitment to the respect of the borders inherited from colonization;
- creation of a council for reconciliation in the Great Lakes.

Such an agreement can guarantee peace in the Great Lakes region, allow a control of the circulation of these weapons on each side of the border in particular as these deadly weapons feed conflicts in these three countries.

As further suggestions on the question of the proliferation of light weapons in connection with the building of peace in the border area between Sudan, Uganda and the DRC, the respondents demand that African countries in general, and the Great Lakes countries in particular develop a culture of peace so as to securitize their respective populations. In addition, they demand that the international community, in particular the countries that manufacture light weapons, should stop supplying the light weapons market in the Great Lakes countries. They also demand that African countries foster the cooperation and development so much desired by their populations and the Great Lakes countries should each year organize meetings meant to assess the problems of development, of the security of their borders, of the proliferation and of the illicit trade of light weapons, inter alia.

#### **4.4. VERIFICATION OF RESEARCH HYPOTHESES**

##### *1. The presence of foreign armies may foster an inflow of weapons in the area.*

The troops of the UPDF (Uganda People's Defence Forces) have remained present in Ituri and North Kivu, even after the signing of the Luanda Agreement in August 2002 between the Congolese and Ugandan governments on the modes of withdrawal of the Ugandan troops from Ituri. If they are officially present in Bunia and on the Congolese side of Mount Rwenzori, at the request of the MONUC and NGO's and in conformity with the agreements concluded with the Government in Luanda, the Ugandans came back to Aru and Mahagi, Rwabisengo (October 20<sup>th</sup>) on the Semliki river (towards October 26<sup>th</sup>). One thousand UPDF soldiers are still in Mutwanga on Lume on the Beni Kasindi – Buera axis.

Many other soldiers (a battalion and a half, according to our local investigators) are stationed in Kamango, a few kilometres from Watalinga. Many other Ugandan soldiers crossed the Semliki river border at Rwabisengo to go and protect the oil wells which a

Canadian firm is planning to exploit on Lake Mobutu. On October 31st, a UPDF battalion stationed in Bunia was deployed from Bunia to Kasese. Colonel SENGAMWENGE, the UPDF operations commanding officer in Bunia during the August confrontations against the RDC/ML was sent to Kasese with his battalion. This same battalion came into Congo via Mutwanga and Kasindi. In Beni, the population was fearing an attack of the town by this battalion. From the 6<sup>th</sup> to the 8<sup>th</sup> of November, an emissary of the pro-UPC Ugandan Generals, Salim SALEH, quoted in the report of the experts of the United Nations on the illegal exploitations of the resources of the DRC visited Beni in order to try to convince the RDC/ML, vaunting the UPC's new acquisitions in heavy weaponry, to leave the control of Beni to the UPC. The RCD answered with devastating offensives on the Komanda-Bunia axis.

The Rwandan support to the UPC in Ituri could be analysed as a response to a possible presence of the Interahamwe in the area. The Rwandan military instructors at the service of the UPC quickly swang towards the Hema militia. (July 2000). The Rwandan Officers used to control the UPC's military operations. Rwanda would have dropped weapons and ammunition for weeks on the hills of the Blue Mount at Mandro (August 2002).

*2. Economic and financial objectives encourage the proliferation of light weapons.*

The territories where our investigations, unfolded, notably Aru, Mahagi, Isiro, Dungu, Doruma, Faradje, Tadu, Bunia, Djegu, Ndrele, Igbokolo,... indicate that the various factions use these places as centers of customs and financial receipts in order to finance their military campaigns. All the war lords and their allies are fighting for territories rich in, for example, gold, diamonds, coltan, wood, with the objective of enriching themselves and continuing to supply these areas with weapons and ammunition.

*3. The existence of ethnic militias and armed gangs favours the proliferation of light weapons.*

Inter-ethnic conflicts, in this case, those which opposed the Lendu to the Hema peoples gave birth to several militias here and there, and these ones are supported by either Uganda or Rwanda and this effectively encourages the intense circulation of light weapons in the hands of these militiamen in the North East of the DRC. This situation, exploited by the neighbouring countries, created other armed gangs of brigands, assassins and criminals who use their weapons in order to extort the goods of the population. This makes it difficult for one to know the number of weapons in circulation in the area.

*4. The inflow of refugees owing to the war might have brought about the proliferation of weapons.*

The inflow of refugees is also a factor which strongly caused the proliferation of light weapons in the area. Indeed, the North East of the DRC accommodated a lot of refugees from Uganda, Rwanda and Sudan owing to the wars in their countries of origin. These refugees came into DRC with their weapons (dissimulated) and started to resell them so as to survive and they launched out in this illicit traffic of light weapons either as salesman, broker or as trader of these deadly weapons.

*5. The inefficient administration of the area may encourage the search of personal safety to the detriment of collective safety, individuals thus getting weapons for their own safety.*

If the civilian population has a great deal of light weapons, this is due to the fact that the administration almost no longer exists, and as there is absence of the State or of the authority of the State, the population does not feel protected, hence the resort to weapons for either one's own protection or the protection of the community.

Through the responses to the survey questionnaire, almost all the respondents declare that they hold weapons for their self-protection vis-à-vis the banditism, criminality, and violence perpetrated by the rebels, because of rape and massive violations of human rights. Hence, the requirement and the urgency to securitize everybody before envisaging a general disarmament. This is how, for example, everybody claims the restoration of the authority of the State or straightforwardly the institution of the rule of law in DRC so as to avoid these violences which put an end to the yet sacred life.

*6. The evacuation of occupying troops may bring about the proliferation of light weapons as these are left behind by these foreign troops.*

Before leaving these troops were disarmed, but their weapons stayed behind and their current whereabouts are unknown. We therefore think that they joined the vicious circle of the proliferation of light weapons.

*7. The use of weapons for poaching purposes increases the circulation of light weapons.*

35% of the respondents think that, for poaching purposes, there are weapons which continue to circulate in the hands of people who are slaughtering the animals in the parks, of which certain species are in the process of disappearance today, in particular the white Rhinoceros.

8. *The illicit trade of weapons for simple lucrative purposes increase the circulation of weapons.*

The mercantile spirit encourages the proliferation of weapons. According to the data collected, the sale of weapons is not in itself beneficial but the use made of them by the holders is.

9. *The plundering of natural resources causes the traffic and the proliferation of light weapons.*

Indeed, the mining resources are financing the purchase of weapons, the war itself, the derisory training of the militia. The important gain drawn from the plundering of natural resources is feeding the infernal cycle of the war as the sleeping partners are not ready yet to loosen the grip.

## **V. STRATEGIES OF FIGHT AND RECOMMENDATIONS**

After collecting and sorting out the research data, the Panel of research tried to summarize and draw from the information that was collected the strategies and recommendations such as suggested by the respondents. These strategies and recommendations are destined to various levels of responsibility.

### **5.1. STRATEGIES**

#### ***5.1.1. At the local and national level***

- To encourage a voluntary handing-over of light weapons in exchange for agricultural tools and plots of land;
- To organise a ceremony of farewell to the weapons collected by burning them (example, the moratorium on light weapons in Mali);
- To carry out public awareness campaigns among the civilian population on the collective danger to hold a weapon a legal permit for carrying arms;
- To resort to coercive measures in the event of the express refusal to abide by the relevant national legislation;

#### ***5.1.1. At the regional level***

- to reinforced the policy of good neighbourhood between the States of the Great Lakes region;
- to devise mechanisms of collective security in the region;
- to restart the political, economic and cultural integration at the regional level for a sustainable development of the populations of the Great Lakes region;

- to install instruments for the control of the traffic and proliferation of light weapons;
- to speed up the democratic processes in progress in the countries concerned with a view to the institution of the rule of law;
- to ratify and implement all the international instruments for human rights with a view to the promotion of human dignity;
- to set up a regional structure for the promotion of human rights;
- to organise a regional conference on peace in the Great Lakes area.

### ***5.1.3. At the international level***

- to install international instruments of the regulation of the production, trade and use of light weapons;
- to set up a specialized structure of the UNO entrusted with questions of the manufacture and control of light weapons;
- to set up a similar structure at the level of the African Union;
- to promote sustainable development in developing countries by means of the financing of employment and income generating activities among the grass-root communities;
- to prohibit the development of the weapons industry and to transform it into an industry for the production of essential convenience equipment in order to support developing countries.

## **5.2. RECOMMENDATIONS FOR ACTIONS IN THE SHORT, MEDIUM AND LONG TERM**

### ***5.2.1. To the government of the DRC***

- to work out a peace education and peaceful conflict resolution training programme for a good cohabitation at all levels (schools, ...)
- to set up or create a truth, peace and reconciliation commission in order to cure the wounds and traumatisms of the inter-ethnic wars;
- to encourage inter-ethnic and trans-ethnic marriages in order to consolidate peace between tribal and ethnic groups;
- to accelerate the process of national reconciliation and of the pacification of the country;
- to restore the authority of the State on the whole of the national territory and to restart the process of the institution of the rule of law;
- to set up mechanisms for the control of the trade and use of light weapons through a rigorous legislation;

- to maintain good relations with neighbouring countries

### ***5.2.2. To the Congolese populations***

- To involve themselves in the process of national reconciliation and to put an end to confrontations between ethnic groups and between communities;
- To renounce violence as a means of conflict settlement by promoting peaceful resolution and dialogue for a peaceful cohabitation;
- To voluntarily return weapons in one's possession and thus decrease the potential for violence in the communities.

### ***5.2.3. To the three countries***

- Each of the neighbouring countries should develop a system of weapons marking/tracking for the weapons used by its security services (the army, the police force, the intelligence agents) and by licensed civilians;
- All the three countries should create a joint military commission for the monitoring and control of the movements of individuals and their property at the borders;
- All the three countries should organise tripartite meetings in order to assess the work of the aforementioned joint military commission;
- The three countries should sign a non aggression pact.

### ***5.2.4. To the international community***

- to accompany the current peace process in DRC;
- to involve itself in the Organisation of the International Conference on peace in the Great Lakes;
- to devise coherent and efficient strategies of fight against the proliferation and the illicit traffic of light weapons.

## CONCLUSION

The real objective of all these efforts for conflict resolution and peace construction is a reconciling stem, increasingly deeper, by all the peoples, all the groups that were in a way or another affected by the conflicts. Peoples, groups and whole communities were affected and ill-treated by wars and conflicts of all kinds. Their spirit and way of life must be cured, they must recover their cultural and organisational richness; they must find themselves as one nation and develop their forces and capacities in order to reconstruct their nations and countries.

These processes of cure and reconstruction require a lot of time and effort, will, and diffidence. They also require particular competences. Once again, our international partners can play a decisive and vivifying role in this long process so as to approach, examine and integrate a very painful history and to help to consider the future with hope and optimism. If we, as peace seeders, in the name of our Christian Faith, must find an inner force to commit ourselves in what is really a demanding ministry, then the problems of a spirituality for conflict resolution and peace construction are capital.

The people that we live with and work for in situations of conflict are our brothers and sisters, spiritual beings with their precise spiritual needs. What we are saying and share with them, the way in which we accompany them in the search for well-being cannot consist of meaningless sentences. That will be nothing for a help, neither for them, nor for us.

These words come from the book of Micah: "what God requires of you is to act with justice, to live with tenderness and to humbly walk about with your God (Micah 6:8).

"To act with justice": this means to identify and transform unjust structures. This means to commit oneself vis-à-vis all the problems of social injustice so that the quality of people's life, especially that of the most stripped, that of the poor and the lunatic may be improved.

"To love with tenderness" relates to our mutual relations. The way in which we are in relation with one another as a people, the way in which we help the others, the way in which we build the human community along with them, the understanding and the decisions that we take in community as brothers and sisters.

"To humbly walk about with your God" helps us to concentrate on the taking of responsibilities of ourselves and for what we are and do; that relates to our growing as



human beings, humble and loving one's fellow human beings, a part of this growth as human beings maintains before our eyes the dimension of justice that is present in all our life. If we live and work along with the others, starting from this spirituality, we can become those people who experience inner peace more, people living in peace and in harmony with others, with THE ONE WHO IS and with all the creation, people enabled to promote this spirit of peace in others.

"The proliferation and illicit trade of small and light weapons" in the border areas between Sudan, Uganda and the DRC is really a complex and stimulating topic, which challenges and must challenge each girl and each son born to the continent in general and to the Great Lakes region in particular. It is already a step that we have started together to reflect on possible strategies and solutions in order to put an end to or otherwise at least reduce the intensity of the circulation of these deadly weapons in our respective countries. As for us, DRC researchers, the thinking is that the findings of the research carried out by our countries will lead to a mobilization and a sensitising of our respective leaders so that they in their turn should mobilize and sensitise our respective populations for a common action.

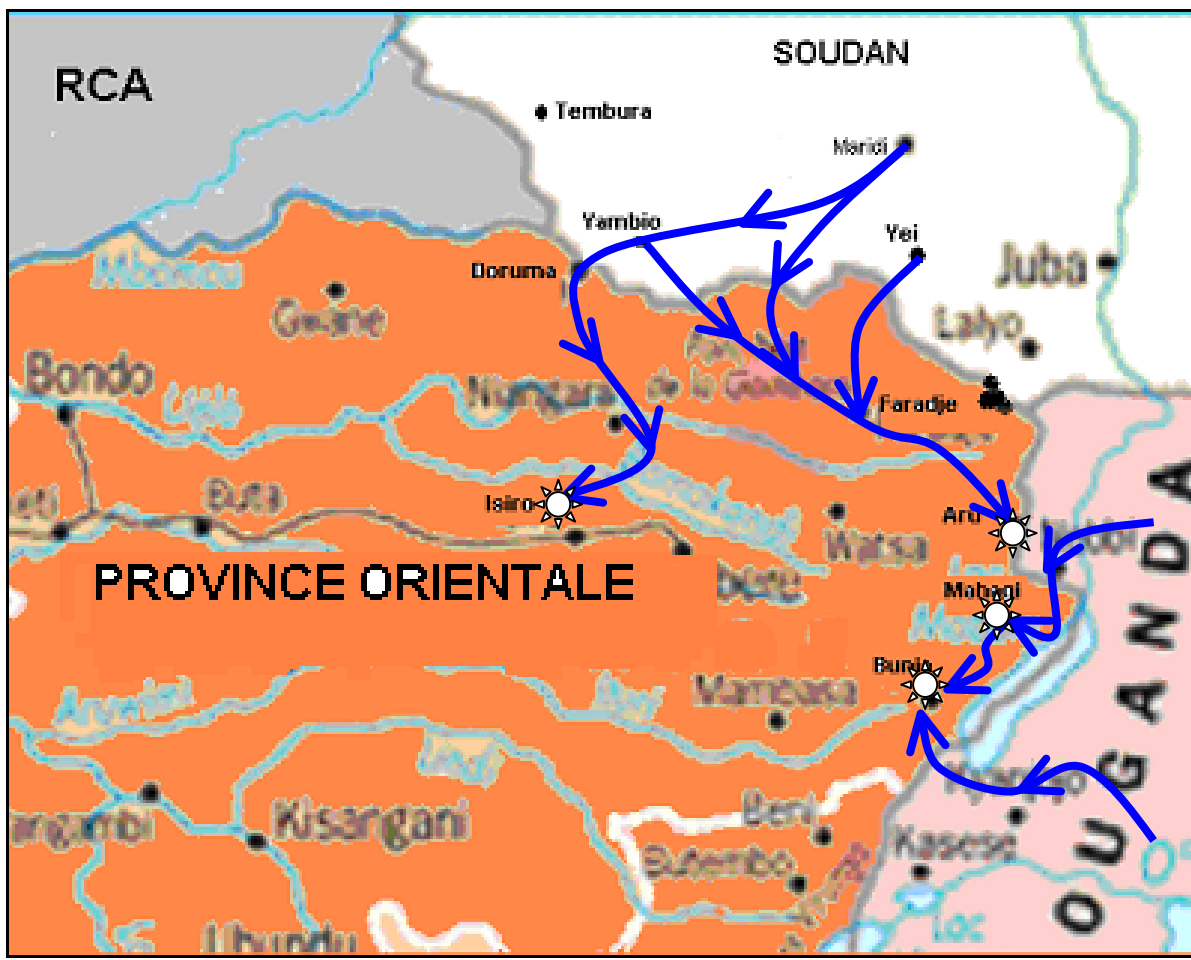
**Fig. 4. Routes of the illicit traffic and proliferation of small and light weapons towards the North East of the DR Congo**



**KEYS**

-  Route of weapons traffic
-  Investigation center